



POCKET COLORIMETER™ II
ANALYSIS SYSTEM
INSTRUCTION MANUAL

Iron, Total (FerroVer® Method)

Important Note

This manual is intended for use with the following Pocket Colorimeter II instrument:

Iron

Cat. No. 59530-22

The Pocket Colorimeter II instrument listed above is **not** interchangeable with any other Pocket Colorimeter Instruments.

Table of Contents

Safety Precautions	1-7
Laboratory Safety	1-7
Use of Hazard Information.....	1-7
Precautionary Labels.....	1-8
Specifications.....	1-9
Instrument Keys and Display.....	1-11
Instrument Cap Cord.....	1-12
Iron, Total.....	1-15
Measuring Hints	1-15
Sampling and Storage.....	1-24
Accuracy Check	1-25
Method Performance.....	1-26
Standard Calibration Adjust Method	1-26
Interferences.....	1-26
Summary of Method	1-28
Reagents and Apparatus.....	1-28

Table of Contents, continued

Instrument Operation.....	2-3
Key Functions.....	2-3
Menu Selections.....	2-4
Switching Ranges.....	2-4
Setting the Time.....	2-4
Recalling Stored Measurements.....	2-5
Battery Installation.....	2-6
Error Codes.....	2-9
Error Messages.....	2-9
Standard Calibration Adjust.....	2-13
User-Entered Calibration.....	2-15
Overview.....	2-15
Calibration Procedure Using Prepared Standards.....	2-17
Entering a Predetermined Calibration Curve.....	2-20
Editing a User-entered or Factory Calibration Curve.....	2-22
Exiting the Calibration Routine.....	2-24
Deleting Calibration Points.....	2-24
Retrieving the Factory Calibration.....	2-25
Maximum/Minimum Displayed Value.....	2-26

Table of Contents, continued

Certification.....	2-29
How to Order.....	2-35
Repair Service	2-37
Warranty	2-38

Safety Precautions

Please read this entire manual before unpacking, setting up, or operating this instrument. Pay particular attention to all danger and caution statements. Failure to do so could result in serious injury to the operator or damage to the equipment.

To ensure the protection provided by this equipment is not impaired, do not use or install this equipment in any manner other than that which is specified in this manual.

Laboratory Safety

As part of good laboratory practice, please familiarize yourself with the reagents used in these procedures. Read all product labels and the material safety data sheets (MSDS) before using them. It is always good practice to wear safety glasses when handling chemicals. Follow instructions carefully. Rinse thoroughly if contact occurs. If you have questions about reagents or procedures, please contact the manufacturer or distributor.

Use of Hazard Information

If multiple hazards exist, this manual will use the signal word (Danger, Caution, Note) corresponding to the greatest hazard.

Safety Precautions, continued

DANGER

Indicates a potentially or imminently hazardous situation which, if not avoided, could result in death or serious injury.

CAUTION

Indicates a potentially hazardous situation that may result in minor or moderate injury.

NOTE

Information that requires special emphasis.

Precautionary Labels

Please pay particular attention to labels and tags attached to the instrument. Personal injury or damage to the instrument could occur if not observed.



This symbol, if noted on the instrument, references the instruction manual for operational and/or safety information.

Specifications

Lamp: Light emitting diode (LED)

Detector: Silicon photodiode

Photometric precision: ± 0.0015 Abs

Filter bandwidth: 15 nm

Wavelength: 500 nm

Absorbance range: -2.0 to 2.5 Abs

Dimensions: 3.2 x 6.1 x 15.2 cm (1.25 x 2.4 x 6 inches)

Weight: 0.2 kg (0.43 lb)

Sample cells: 25 mm (10 mL), AccuVac® Ampules

Operating conditions: 0 to 50 °C (32 to 122 °F); 0 to 90% relative humidity (noncondensing)

Power supply: Four AAA alkaline batteries; approximate life is 2000 tests*

* Backlight usage will decrease battery life.

OPERATION

DANGER

Handling chemical samples, standards, and reagents can be dangerous. Review the necessary Material Safety Data Sheets and become familiar with all safety procedures before handling any chemicals.

DANGER

La manipulation des échantillons chimiques, étalons et réactifs peut être dangereuse. Lire les Fiches de Données de Sécurité des Produits (FDSP) et se familiariser avec toutes les procédures de sécurité avant de manipuler tous les produits chimiques.

PELIGRO

La manipulación de muestras químicas, estándares y reactivos puede ser peligrosa. Revise las fichas de seguridad de materiales y familiarícese con los procedimientos de seguridad antes de manipular productos químicos.

GEFAHR

Das Arbeiten mit chemischen Proben, Standards und Reagenzien ist mit Gefahren verbunden. Es wird dem Benutzer dieser Produkte empfohlen, sich vor der Arbeit mit sicheren Verfahrensweisen und dem richtigen Gebrauch der Chemikalien vertraut zu machen und alle entsprechenden Materialsicherheitsdatenblätter aufmerksam zu lesen.

PERIGO

A manipulação de amostras, padrões e reagentes químicos pode ser perigosa. Reveja a folha dos dados de segurança do material e familiarize-se com todos os procedimentos de segurança antes de manipular quaisquer produtos químicos.

PERICOLO

La manipolazione di campioni, standard e reattivi chimici può essere pericolosa. La preghiamo di prendere conoscenza delle Schede Tecniche necessarie legate alla Sicurezza dei Materiali e di abituarsi con tutte le procedure di sicurezza prima di manipolare ogni prodotto chimico.

Instrument Keys and Display

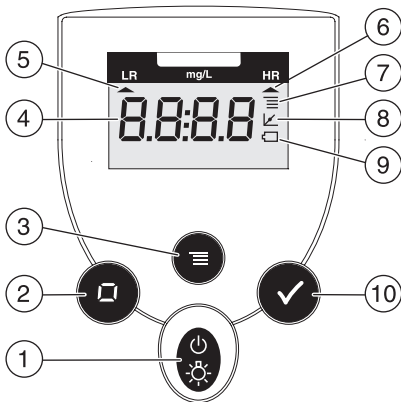

Item	Description
1	POWER/BACKLIGHT Key
2	ZERO/SCROLL Key
3	MENU Key
4	Numeric Display
5	Range Indicator
6	Range Indicator
7	Menu Indicator
8	Calibration Adjusted Indicator
9	Battery Low Indicator
10	READ/ENTER Key

Instrument Cap Cord

The instrument cap for the Pocket Colorimeter™ II doubles as a light shield. Accurate measurements cannot be obtained unless the sample or blank is covered with the cap. Use the instrument cap cord to secure the cap to the body of the colorimeter and prevent loss of the cap. See [Figure 1 on page 1–13](#).

1. Loop the instrument cap cord through the ring on the cap.
2. Remove the battery compartment cover. Press the knotted end of the cord into the hole indicated by the arrow.
3. Slide the cord into the slot on the battery compartment cover. Snap the cover into place.

Figure 1 Attaching the Instrument Cap Cord

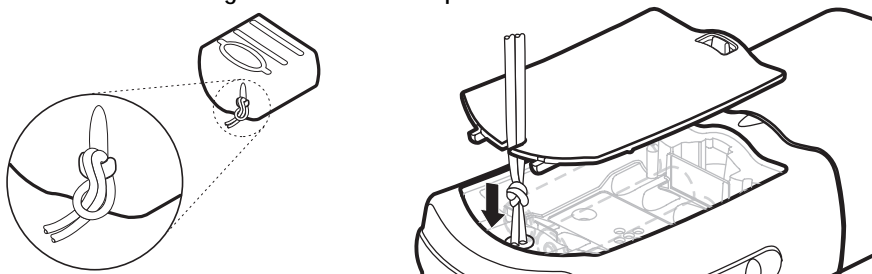

Iron, Total (0.02 to 5.00 mg/L)

Method 8008

For water, wastewater, and seawater. USEPA accepted for wastewater*

FerroVer[®] Method**

(PermaChem[®] Powder Pillows or AccuVac[®] Ampuls)

Measuring Hints

- If samples cannot be analyzed immediately, see [Sampling and Storage on page 1–24](#).
- After adding reagent, an orange color will form if iron is present.
- Accuracy is not affected by undissolved powder.
- For turbid samples, treat the blank by adding one 0.1-g scoop of RoVer[®] Rust Remover. Swirl to mix.

Note: *The Pocket Colorimeter II is designed to measure solutions contained in sample cells. DO NOT dip the meter in the sample or pour the sample directly into the cell holder.*

* Federal Register 45(126) 43459 (June 27, 1980).

** Adapted from *Standard Methods for Examination of Water and Wastewater*.

Iron, Total, continued

Iron, Total (using Powder Pillows)

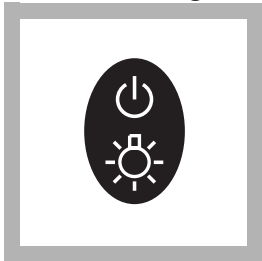

1. Press the **POWER** key to turn the meter on.

The arrow should indicate mg/L Fe.

Note: See [page 2–4](#) for information on selecting the correct range channel.



2. Fill a 10-mL sample cell to the 10-mL line with sample.

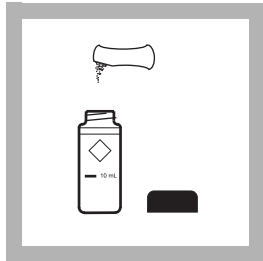

3. Add the contents of one FerroVer Powder Pillow to the sample cell (the prepared sample). Cap the cell.

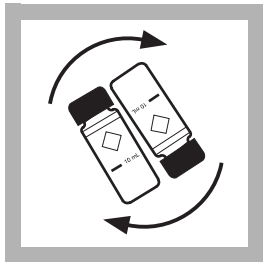

4. Invert the sample cell several times to mix. Wipe off any liquid or fingerprints.

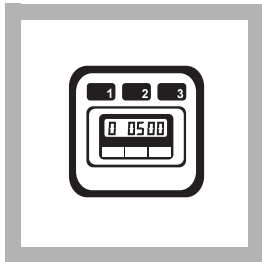

5. Wait 3 minutes.

Note: *Samples containing visible rust should be allowed to react at least 5 minutes.*

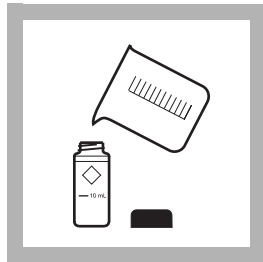

6. Fill a second sample cell with 10 mL of sample (the blank). Wipe off any liquid or fingerprints.

Iron, Total, continued

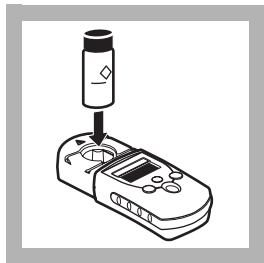

7. Place the blank in the cell holder.

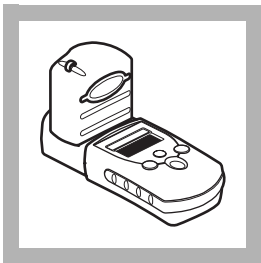

8. Cover the blank with the instrument cap.

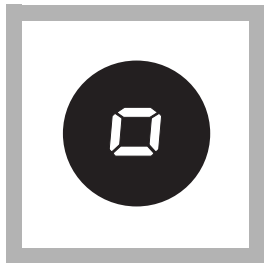

9. Press **ZERO/SCROLL**.
The display will show
"- - - -" then "0.00".
Remove the blank from the
cell holder.

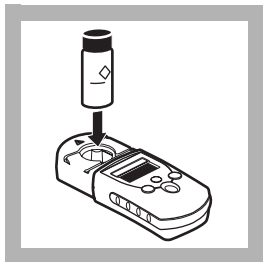

10. Within 5 minutes after the reaction period ends, place the prepared sample in the cell holder.

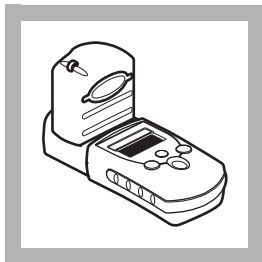

11. Cover the sample cell with the instrument cap.

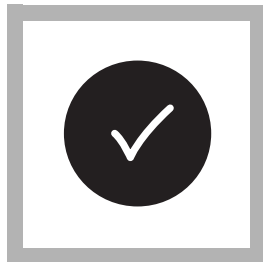

12. Press **READ/ENTER**.
The display will show “- - - -”, followed by results in mg/L iron.

Iron, Total, continued

Iron (using AccuVac® Ampuls)

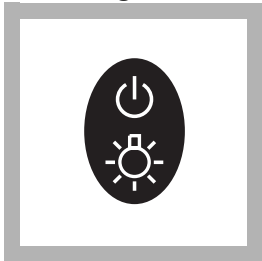

1. Press the **POWER** key to turn the meter on.

The arrow should indicate mg/L Fe.

Note: See [page 2–4](#) for information on selecting the correct range channel.



2. Fill a 10-mL sample cell to the 10-mL line with sample (the blank). Cap the cell. Collect at least 40 mL of sample in a 50-mL beaker.

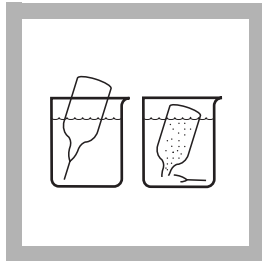

3. Fill a FerroVer AccuVac Ampul with sample. Keep the tip of the ampule immersed until the ampule fills completely.

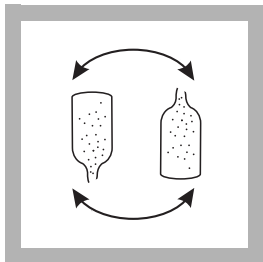

4. Quickly invert the ampul several times to mix. Wipe off any liquid or fingerprints.



5. Wait 3 minutes.

Note: *Samples containing visible rust should be allowed to react at least 5 minutes.*

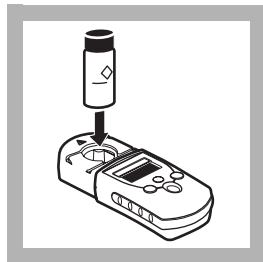

6. Place the blank in the cell holder.

Iron, Total, continued

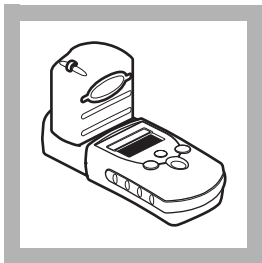

7. Cover the blank with the instrument cap.



8. Press **ZERO/SCROLL**.
The display will show
"- - - -" then "0.00".
Remove the blank from the
cell holder.

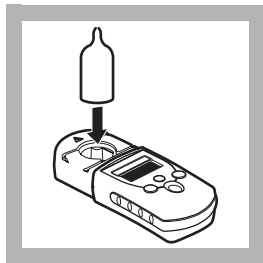

9. Place the ampule in the
cell holder.

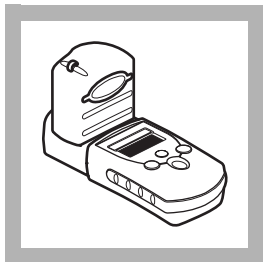

10. Cover the sample cell with the instrument cap.

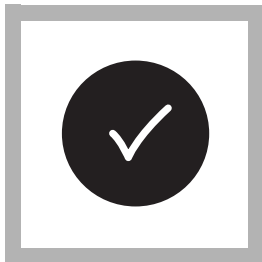

11. Press **READ/ENTER**.
The display will show " - - - - ", followed by results in mg/L iron.

Sampling and Storage

Collect samples in acid-cleaned glass or plastic containers. No acid addition is necessary if immediately analyzing the sample. To preserve samples, adjust the pH to 2 or less with nitric acid (about 2 mL per liter). Preserved samples may be stored up to six months at room temperature. Adjust the pH between 3 and 5 with 5.0 N Sodium Hydroxide Standard Solution before analysis. Correct the test result for acid or base additions by using the following equation:

$$\frac{\text{final sample volume (mL)} \times \text{test result (mg/L)}}{\text{initial sample volume before addition of acid or base (mL)}} = \text{correct sample concentration (mg/L)}$$

See the “Sample Pretreatment” section of the Water Analysis Handbook for more information about digestions. Use the mild, vigorous, or Digesdahl® digestion procedure.

Accuracy Check

Standard Additions Method

1. Using a graduated cylinder, measure 25.0 mL of sample into each of three 50-mL beakers.
2. Snap the neck off an Iron Standard PourRite™ Ampule, 50 mg/L Fe.
3. Use a TenSette® Pipet to add 0.1, 0.2, and 0.3 mL of standard, respectively, to the three beakers. Mix thoroughly.
4. For analysis with powder pillows, transfer only 10 mL of solution to the 10-mL sample cells.
5. Analyze each standard addition sample as described in the procedure. The iron concentration should increase 0.2 mg/L for each 0.1 mL of standard added.

Standard Solution Method

Use a 3.00 mg/L iron standard solution in place of the sample. Perform the Standard Additions Method as described above. Prepare the 3.00 mg/L standard by pipetting 3.00 mL of a 100 mg/L iron standard solution into a 100-mL volumetric flask. Dilute to volume with deionized water. Stopper and mix thoroughly. Prepare fresh daily.

Iron, Total, continued

Method Performance

Typical Precision (95% CI):

1.00 ± 0.2 mg/L Fe

Estimated Detection Limit:

EDL = 0.02 mg/L Fe

Standard Calibration Adjust Method

To perform a standard calibration adjustment using the 3.0 mg/L standard or an alternative concentration, see [Standard Calibration Adjust on page 2–13](#).

Interferences

The following interfere at levels above those concentrations listed:

Chloride	185,000 mg/L
Calcium	10,000 mg/L as CaCO ₃
Magnesium	100,000 mg/L as CaCO ₃
Molybdate Molybdenum	50 mg/L as Mo

A large excess of iron will inhibit color development. A diluted sample should be tested if there is any doubt about the validity of a result.

FerroVer[®] Iron Reagent Powder Pillows and AccuVac Ampuls contain a masking agent that eliminates potential interferences from copper.

Samples containing some forms of iron oxide require the mild, vigorous or Digesdahl[®] digestion. After digestion adjust the pH to 2.5–5 with ammonium hydroxide.

Samples containing large amounts of sulfide should be treated in a fume hood or well-ventilated area as follows:

1. Add 5 mL of Hydrochloric Acid to 100 mL of sample and boil for 20 minutes.
2. Adjust the pH to 2.5–5 with 5 N Sodium Hydroxide and adjust the volume to 100 mL with deionized water.
3. Analyze as described in the procedure. Highly buffered samples or extreme sample pH may exceed the buffering capacity of the reagents. If this is suspected, adjust the sample pH to 3–5 before analysis.

Iron, Total, continued

Summary of Method

FerroVer Iron Reagent reacts with all soluble iron and limited quantities of most insoluble forms of iron in the sample to produce soluble ferrous iron. This reacts with the 1,10-phenanthroline indicator in the reagent to form an orange color in proportion to the iron concentration.

Reagents and Apparatus

Required Reagents and Apparatus (Using Powder Pillows)

Description	Units	Cat. No.
FerroVer [®] Iron Reagent.....	100/pkg	21057-69
Sample Cell, 10-mL, with cap.....	each	24276-01

Required Reagents and Apparatus (Using AccuVac Ampuls)

FerroVer [®] Iron Reagent AccuVac [®] Ampuls.....	25/pkg	25070-25
Beaker, 50-mL.....	each	500-41H

Optional Reagents

Description	Units	Cat. No.
Ammonium Hydroxide, ACS	500 mL.....	106-49
Hydrochloric Acid Standard Solution, 6 N (1:1).....	500 mL.....	884-49
Hydrochloric Acid, ACS	500 mL.....	134-49
Iron Standard Solution, 1.00 mg/L.....	500 mL.....	139-49
Iron Standard Solution, 100 mg/L.....	100 mL.....	14175-42
Iron Standard Solution, PourRite™ Ampules, 50 mg/L, 2 mL	20/pkg.....	14254-20
Nitric Acid, ACS	500 mL.....	152-49
Nitric Acid Solution, 1:1	500 mL.....	2540-49
RoVer® Rust Remover	454 g.....	300-01
Rust Suspension	15 mL DB.....	1279-36
Sodium Hydroxide Standard Solution, 5.0 N.....	100 mL MDB.....	2450-32
Water, deionized.....	4 L.....	272-56

Optional Apparatus

AccuVac® Snapper	each.....	24052-00
Ampule Breaker	each.....	24846-00
Beaker, 250 mL.....	each.....	500-46H

Iron, Total, continued

Optional Apparatus, continued

Description	Units	Cat. No.
Cylinder, graduated, poly, 25 mL	each	1081-40
Cylinder, graduated, poly, 100 mL	each	1081-42
Filter Discs, glass, 47 mm.....	100/pkg	2530-00
Filter Holder, glass, membrane	each	2340-00
Filter Pump.....	each	2131-00
Flask, Erlenmeyer, 250 mL.....	each	505-46
Flask, filtering, 500 mL.....	each	546-49
Flask, volumetric, Class A, 100 mL.....	each ...	14574-42
Hot Plate, 3.5 in. diameter, 120 V ac.....	each ...	12067-01
pH Indicator Paper, 1 to 11 pH	5/pkg	391-33
Pipet Filler, safety bulb.....	each ...	14651-00
Pipet, serological, 2 mL	each	532-36
Pipet, serological, 5 mL	each	532-37
Pipet, TenSette [®] , 0.1 to 1.0 mL	each	19700-01
Pipet Tips for 19700-01 TenSette [®] Pipet	50/pkg ...	21856-96
Pipet, volumetric, Class A, 3.00 mL.....	each ...	14515-03
Pipet, volumetric, Class A, 5.00 mL.....	each ...	14515-37

Optional Apparatus, continued

Description	Units	Cat. No.
Spoon, measuring, 0.1 g	each.....	511-00
Watch Glass, 100 mm.....	each.....	578-70

Replacement Parts

Batteries, AAA, alkaline.....	4/pkg.....	46743-00
Instrument Cap/light shield	each.....	59548-00
Instruction Manual, Iron.....	each.....	59581-88
Sample Cell, 10-mL, with cap.....	6/pkg.....	24276-06





Section 2

Instrument Manual

Instrument Operation

Key Functions

Key	Description	Function
	POWER	On/Off/Backlight To turn on the backlight, turn on the instrument, then press and hold the power key until the backlight turns on. Press and hold again to turn off the backlight. This key functions the same in all instrument modes and ranges.
	ZERO/SCROLL	In measurement mode, sets the instrument to zero. In menu mode, scrolls through menu options. Also scrolls numbers when entering or editing a value.
	READ/ENTER	In measurement mode, initiates sample measurement. In menu mode, selects a menu option. When entering numbers, moves one space to the right and executes the function when the entry is complete.

Instrument Operation, continued

Key	Description	Function
	MENU	Enter/Exit the menu mode Press and hold for approximately 5 seconds to enter user-entered method mode.

Menu Selections

Press the **MENU** key to access the menu selections.

Switching Ranges

1. Press the **MENU** key. The display will show “SEL”. A flashing arrow indicates the current range.
2. Press the **READ/ENTER** key to toggle between ranges.
3. Press **MENU** again to accept and exit back to the measurement screen.

Setting the Time

1. Press the **MENU** key, then press the **ZERO/SCROLL** key until the display shows a time in the “00:00” format.

2. Press **READ/ENTER**. The digit to be edited will flash.
3. Use the **ZERO/SCROLL** key to change the entry, then press **READ/ENTER** to accept and advance to the next digit. The time is entered in 24-hour format.

Recalling Stored Measurements

1. Press the **MENU** key, then press the **ZERO/SCROLL** key until the display shows RCL. The instrument automatically stores the last 10 measurements.
2. In RCL, press **READ/ENTER** to recall the stored measurements, beginning with the most recent measurement taken. The meter stores the measurement number as 01 (most recent) through 10 (oldest), the time the measurement was taken, and the measurement value. The **ZERO/SCROLL** key allows for selection of a specific measurement by number. The **READ/ENTER** key scrolls through all stored data points.



Battery Installation

Figure 1 on page 2–7 provides an exploded view of battery installation.

1. Unhook the latch and remove the battery compartment cover. The polarities are shown on the battery holder.
2. Place the four batteries provided with the instrument in the holder as indicated and replace the battery compartment cover. The display will show the software version number (e.g., “P 1.6”) after correct battery installation.

When replacing discharged batteries, always replace the complete set of four alkaline batteries. **Rechargeable batteries are not recommended** and cannot be recharged in the instrument.

Note: *The Low Battery icon will appear on the display when the batteries have 10% battery life remaining. The battery icon will flash when the batteries are too low to complete measurements. See [Instrument Keys and Display on page 1–11](#).*

Figure 1 Battery Installation

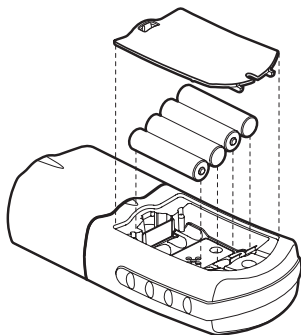

Error Codes

When the instrument cannot perform the function initiated by the operator, an error message will appear in the display. Refer to the appropriate message information below to determine what the problem is and how it can be corrected. Resolve error messages in the order that they appear on the display. Service Centers are listed in [page 2–37](#).

Error Messages

1. E-0 No Zero (User mode)

Error occurs when trying to read a standard in the user calibration mode before setting the meter to zero.

- Zero the instrument on an appropriate blank.

2. E-1 Ambient Light Error

There is too much light present to take a valid measurement.

- Verify instrument cap is correctly seated.
- If the problem persists, contact a Service Center ([page 2–37](#)).

Error Codes, continued

3. E-2 LED Error

The LED (light source) is out of regulation.

- Replace batteries.
- Verify LED lights up (inside the cell holder) when the **READ/ENTER** or **ZERO/SCROLL** key is pressed.
- If the problem persists, contact a Service Center ([page 2–37](#)).

Note: When an E-1 or E-2 error occurs on a measurement, the display will show “_._.” (The decimal place is determined by the chemistry.) If the E-1 or E-2 error occurs while zeroing the meter, the meter will require the user to re-zero.

4. E-3 Standard Adjust Error

The value obtained on the prepared standard exceeds the adjustment limits allowed for the standard concentration, or the concentration of the standard is outside the concentration range allowed for standard calibration adjust.

- Prepare the standard and rerun according to the procedure.
- Prepare a standard at or near the recommended concentrations given in the procedure.
- Verify that the concentration of the standard has been entered correctly.

- If the problem persists, contact a Service Center ([page 2–37](#)).

5. E-6 Abs Error (User mode)

Indicates that the absorbance value is invalid, or indicates an attempt to make a curve with less than two points.

- Enter or measure the absorbance value again.
- If the problem persists, contact a Service Center ([page 2–37](#)).

6. E-7 Standard Value Error (User mode)

Standard concentration is equal to another standard concentration that is already entered.

- Enter the correct standard concentration.
- If the problem persists, contact a Service Center ([page 2–37](#)).

7. E-9 Flash Error

The meter is unable to save data.

- If the problem persists, contact a Service Center ([page 2–37](#)).

Error Codes, continued

8. Underrange—flashing number below stated test range

- Verify instrument cap is correctly seated.
- Check zero by measuring a blank. If error recurs, re-zero the instrument.
- If the problem persists, contact a Service Center ([page 2–37](#)).

Note: See *Maximum/Minimum Displayed Value on page 2–26* for more information.

9. Overrange—flashing number above stated test range

Note: *Flashing value will be 10% over the upper test limit.*

- Check for light blockage.
- Dilute and retest sample.

Note: See *Maximum/Minimum Displayed Value on page 2–26* for more information.

Standard Calibration Adjust

The Pocket Colorimeter™ II instrument is factory-calibrated and ready for use without user calibration. Use of the factory calibration is recommended unless the user is required to generate a calibration. The Standard Calibration Adjust can be used to meet regulatory requirements.

This feature allows the factory default calibration curve to be adjusted with a known standard. Use the standard described in the procedure.

1. Place a blank in the meter (in measurement mode). Press **ZERO/SCROLL**.
2. Place the reacted standard in the meter. Press **READ/ENTER**.
3. Press **MENU**, then press **ZERO/SCROLL** until the display shows “SCA”.
4. Press **READ/ENTER** to display the standard calibration adjust value.
5. Press **READ/ENTER** to adjust the curve to the displayed value. The meter will return to the measurement mode and the Calibration Adjusted icon will appear in the display window.

If an alternate concentration is used, or if a standard concentration is not given:

6. Repeat steps 1–4.

Standard Calibration Adjust, continued

7. Press **ZERO/SCROLL** to access the Edit function, then press **READ/ENTER** to begin editing. The digit to be edited will flash. Use the **ZERO/SCROLL** key to change the entry, then press **READ/ENTER** to accept and advance to the next digit.

When the last digit is entered, press **READ/ENTER** and the meter will adjust the curve to the value entered. The meter will return to measurement mode and the Calibration Adjusted icon will appear in the display window.

To turn off Standard Calibration Adjust (SCA):

1. Press **MENU**.
2. Press **ZERO/SCROLL** until “SCA” appears in the display.
3. Press **READ/ENTER**, then press **ZERO/SCROLL** until “Off” appears in the display.
4. Press **READ/ENTER** to turn off SCA.

Note: Perform another standard calibration adjust to turn SCA on again.

Note: For meters with factory-calibrated ranges or methods, Standard Calibration Adjust (SCA) will be disabled when a user-entered method is programmed into the meter. To turn SCA back on, restore the meter to factory default calibration. See Retrieving the Factory Calibration on page 2–25.

User-Entered Calibration

Overview

The Pocket Colorimeter™ II will accept a user-prepared calibration curve. The curve can extend from 0 to 2.5 absorbance. A user-prepared calibration curve may be entered into any channel that does not contain a factory-programmed curve. These channels are labeled “abs” on instruments having a single factory calibration or are labeled “1” and “2” on the uncalibrated single wavelength instruments. Any chemistry that can be run at the instrument wavelength may be user-entered in these channels.

Using prepared standard solutions that cover the range of interest, the meter generates a calibration curve by calculating the straight-line segments between each standard entered. A calibration curve may be entered using the keypad. Factory-entered calibration curves may also be recalculated or adjusted using the same procedure.

To enter the user-entered calibration mode, press the **MENU** key and hold it down until the display shows “USER” (about 5 seconds), followed by “CAL”. Press **ZERO/SCROLL** to scroll through the options.

*Note: If the meter does not display USER followed by CAL after pressing the **MENU** key, the factory calibration cannot be modified on this channel.*

User-Entered Calibration, continued

- CAL—Used to enter and edit standard values and measure absorbance values, or review the existing calibration.
- Edit—Used to enter and edit standard values and absorbance values with the keypad or review the existing calibration. Used to enter a predetermined calibration curve.
- dFL—Used to return the instrument back to the default factory calibration. User-entered calibrations are stored upon exit from the calibration or edit modes.

Note: *To return to factory settings, following the instructions in [Retrieving the Factory Calibration on page 2–25](#).*

If the instrument is shut off or loses power during data entry, all edits will be lost. Automatic shut-off in user-entered calibration entry mode is 60 minutes.

CAL and Edit Submenus

In CAL mode, standard values are entered and absorbance values are measured. In Edit mode, standard and absorbance values are entered.

- To select CAL from the User menu, press **READ/ENTER**.
- To select Edit from the User menu, press **ZERO/SCROLL** and **READ/ENTER**.

- Once in the CAL or Edit option, press the **READ/ENTER** key to navigate through each option.

Note: Press **ZERO/SCROLL** to quickly scroll through each option.

Calibration Procedure Using Prepared Standards

Note: *Deionized water or a reagent blank can be used to zero during the calibration procedure. Calibrations generated with deionized water as the zero will give less accurate results if the reagent blank is significantly more turbid or colored than deionized water. Use the deionized water or the reagent blank as the zero concentration point (SO) in the following calibration procedure.*

1. Turn on the instrument and select the range to be calibrated. An arrow at the top of the display will point to the selected range. To change ranges, press the **MENU** key, then use the **READ/ENTER** key to toggle between ranges 1 and 2. Press **MENU** again to return to measurement mode.
2. Follow the procedure for the chemical method to be calibrated. Prepare a reagent blank (if needed) and a standard solution. Allow the color to develop fully.

User-Entered Calibration, continued

3. Insert the reagent blank or deionized water into the meter and cover with the cap. Press the **ZERO/SCROLL** key. The meter will display “- - -”, followed by “0.000”. This initializes (zeroes) the meter.
4. Press the **MENU** key and hold it down until the display shows “USER”, followed by “CAL”. Press **READ/ENTER** to enter the calibration mode.
5. In factory-calibrated meters, S0 will appear in the display.

Note: When recalibrating a factory-calibrated meter or range, RES (resolution) cannot be changed.

6. In uncalibrated meters or meters with ranges labeled Abs, “RES” will appear. Press **ZERO/SCROLL** to review the current resolution (decimal placement). Press **ZERO/SCROLL** again to accept the current resolution. To change the resolution, press **READ/ENTER**, then **ZERO/SCROLL** to change the resolution. Press **READ/ENTER** to accept the new resolution. “S0” will appear on the display.
7. Press the **READ/ENTER** key again, then enter the blank value.

*Note: Press the **READ/ENTER** key to move from digit to digit. Use the **ZERO/SCROLL** key to change the number.*

8. After completing entry of the blank value, press the **READ/ENTER** key. The display will show “A0”.

User-Entered Calibration, continued

9. Insert the reagent blank or deionized water into the cell holder. Cover the blank with the instrument cap.
10. Press the **READ/ENTER** key. The meter will measure and display the absorbance value for “S0”.
11. Remove the sample blank. Press the **ZERO/SCROLL** key. “S1” will appear. Press the **READ/ENTER** key, then enter the first standard value.

*Note: Press the **READ/ENTER** key to move from digit to digit. Use the **ZERO/SCROLL** key to change the number.*

12. After completing entry of the first standard value, press the **READ/ENTER** key. The display will show “A1”.
13. Insert the first reacted standard solution into the cell holder. Cover the prepared standard with the instrument cap.
14. Press the **READ/ENTER** key. The meter will measure and display the absorbance value for S1.
15. The calibration is complete with two points. If additional standards are required, press **ZERO/SCROLL** until “Add” appears on the display. Repeat steps 11–14 to enter additional standards.

User-Entered Calibration, continued

16. Press the **MENU** key twice to exit and accept the changes. The instrument will use this calibration to determine the displayed concentration of future sample measurements.

Entering a Predetermined Calibration Curve

Note: Entering a predetermined calibration curve requires at least two data pairs. Each data pair requires a concentration value and the absorbance value for the given concentration. Up to 10 data pairs may be entered. This procedure uses the Edit mode.

1. Turn on the instrument and select the range to be calibrated. An arrow at the top of the display will point to the selected range. To change ranges, press the **MENU** key, then use the **READ/ENTER** key to toggle between ranges 1 and 2. Press **MENU** again to return to measurement mode.
2. Press the **MENU** key and hold it down until the display shows “USER”, followed by “CAL”. Press **ZERO/SCROLL** to scroll to EDIT. Press **READ/ENTER**.
3. In uncalibrated meters or in Abs range, “RES” will appear. Press **ZERO/SCROLL**. To change the resolution (decimal placement), press **READ/ENTER**. Press **ZERO/SCROLL** to select the new resolution, then press **READ/ENTER** to accept. “S0” will appear on the display.

User-Entered Calibration, continued

4. Enter the concentration value and absorbance value of the first data pair (S0, A0).
5. To enter the S0 value, press **READ/ENTER**. Use the **ZERO/SCROLL** key to select the numerical value, then press the **READ/ENTER** key to accept the entry and advance to the next decimal place. Repeat this sequence until the S0 concentration value is entered.
6. After editing the S0 value, press **READ/ENTER** to accept. "A0" will appear on the display.
7. To enter the absorbance value for S0, press the **READ/ENTER** key to go to entry mode. Use the **ZERO/SCROLL** key to select the numerical value, then press the **READ/ENTER** key to accept the entry and advance to the next decimal place. Repeat this sequence until the absorbance value for S0 is entered.
8. After entering A0, press **READ/ENTER** to accept. "S1" will appear on the display.
9. Repeat steps 5 through 8 for each standard value and absorbance value pair in the calibration curve

*Note: After A1 is entered, Add will appear in the display. If additional data pairs are to be entered, press **READ/ENTER** and continue with step 9.*

User-Entered Calibration, continued

10. When all the calibration data has been entered, press **MENU** twice to return to the measurement mode.

Editing a User-entered or Factory Calibration Curve

1. Press the **MENU** key and hold it down until the display shows “USER”, followed by “CAL”. Press **ZERO/SCROLL** until EDIT appears.

*Note: If the meter does not display USER followed by CAL after pressing the **MENU** key, the factory calibration cannot be modified on this channel.*

2. Press the **READ/ENTER** key to enter Edit mode. In factory-calibrated meters, “S0” will appear in the display.

Note: When editing a factory-calibrated meter or range, RES (resolution) cannot be changed.

*Note: When RES or S0 appears in the display, press **ZERO/SCROLL** to quickly scroll to the data to be edited.*

3. In uncalibrated meters or in Abs range, “RES” will appear. Press **ZERO/SCROLL** to review the current resolution. Press **ZERO/SCROLL** again to accept the displayed resolution. To change the resolution (decimal placement), press

User-Entered Calibration, continued

READ/ENTER. Press **ZERO/SCROLL** to select the new resolution, then press **READ/ENTER** to accept. "S0" will appear on the display.

4. Press **READ/ENTER**. The current concentration value for S0 will appear on the display.
5. To edit the S0 value, press **READ/ENTER**. Use the **ZERO/SCROLL** key to select the numerical value, then press the **READ/ENTER** key to accept the entry and advance to the next decimal place. Repeat this sequence until the S0 concentration value is entered.
6. After editing the S0 value, press **READ/ENTER** to accept. "A0" will appear on the display.
7. To edit the absorbance value for S0, press the **READ/ENTER** key to go to entry mode. Use the **ZERO/SCROLL** key to select the numerical value, then press the **READ/ENTER** key to accept the entry and advance to the next decimal place. Repeat this sequence until the absorbance value for S0 is entered.
8. After editing A0, press **READ/ENTER** to accept. "S1" will appear on the display.
9. Repeat steps 4 through 8 for each standard value and absorbance value pair in the calibration curve.

User-Entered Calibration, continued

10. When all calibration data has been reviewed or edited, “ADD” will appear in the display.
11. Press **READ/ENTER** to add more calibration points, or press **MENU** twice to return to the measurement mode.

Note: When a factory calibration curve has been edited, the “calibration adjust” icon will appear in the display.

Exiting the Calibration Routine

Exit the calibration routine by pressing the **MENU** key to return to measurement mode. The instrument uses the last completed user-entered calibration or the factory calibration if no user-entered calibration has been completed.

Deleting Calibration Points

1. Select the range containing user-entered calibration points. See [Switching Ranges on page 2–4](#).
2. Press and hold the **MENU** key until “USER”, then “CAL” appears. Press **READ/ENTER**.

Note: Calibration points can also be deleted in Edit mode.

3. Press **ZERO/SCROLL** to select the point to delete (e.g., S0 or S1 or S2). Press **READ/ENTER**.
4. The left digit will flash. Press **ZERO/SCROLL** until “dEL” appears. (“dEL” will appear after the numeral 9.)
5. Press **READ/ENTER** to delete. Repeat for all points to be deleted.
Note: The minimum number of valid points is two. For example, if five points have been entered, three can be deleted using this feature.
6. Press **MENU** to return to the measurement mode.

Retrieving the Factory Calibration

1. Select the range to restore factory default calibration. See [Switching Ranges on page 2–4](#).
2. Press and hold the **MENU** key until “USER”, then “CAL” appears.
*Note: If the meter does not display USER followed by CAL after pressing the **MENU** key, the factory calibration cannot be modified on this channel.*
3. Press the **ZERO/SCROLL** key to find dFL.

User-Entered Calibration, continued

4. Press the **READ/ENTER** key to select dFL and restore the instrument to the factory default calibration.

Note: For meters with factory-calibrated ranges or methods, Standard Calibration Adjust (SCA) will be disabled when a user-entered method is programmed into the meter. To turn SCA back on, restore the meter to factory default calibration.

Maximum/Minimum Displayed Value

In meters with absorbance (Abs) ranges, the maximum displayed value and minimum displayed value is related to the value of the standards entered in a user calibration.

Measurements that exceed the minimum or maximum standards entered in the user calibration will return a flashing number indicating “underrange” or “overrange”. See *Error Codes* (page 2–12) for more information.

Example 1

For a calibration with the following standards:

User-Entered Calibration, continued

S0=0.000

S1=1.000

Maximum Displayed Value	1.000
Minimum Displayed Value	0.000

Example 2

For a calibration with the following standards:

S0=1.00

S1=2.00

S2=4.00

Maximum Displayed Value	4.00
Minimum Displayed Value	1.00

For Hach-calibrated programs, the maximum and minimum displayed values always equal the factory-calibrated values and cannot be changed.

Certification

Hach Company certifies this instrument was tested thoroughly, inspected, and found to meet its published specifications when it was shipped from the factory.

The Pocket Colorimeter™ II instrument has been tested and is certified as indicated to the following instrumentation standards:

EMC Immunity:

Per **89/ 336/ EEC EMC: EN 61326: 1998** (Electrical Equipment for measurement, control and laboratory use—EMC requirements). Supporting test records by Hach Company, certified compliance by Hach Company.

Standard(s) include:

IEC 1000-4-2: 1995 (EN 61000-4-2: 1995) Electro-Static Discharge Immunity (Criteria B)

IEC 1000- 4- 3: 1995 (EN 61000- 4- 3: 1996) Radiated RF Electro- Magnetic Field Immunity (Criteria A)

Additional Immunity Standard(s) include:

ENV 50204: 1996 Radiated Electromagnetic Field from Digital Telephones

Certification, continued

(Criteria A) Radio Frequency Emissions:

Per **89/ 336/ EEC EMC: EN 61326: 1998** (Electrical Equipment for measurement, control and laboratory use—EMC requirements) “Class B” emission limits.

Supporting test records from Hach EMC Test Facility, certified compliance by Hach Company.

Additional Radio Frequency Emissions Standard(s) include:

EN 55022 (CISPR 22), Class B emissions limits.

Canadian Interference-causing Equipment Regulation, IECS-003, Class A:

Supporting test records from Hach EMC Test Facility, certified compliance by Hach Company.

This Class A digital apparatus meets all requirements of the Canadian Interference-causing Equipment Regulations.

Cet appareil numérique de la classe A respecte toutes les exigences du Règlement sur le matériel brouilleur du Canada.

FCC Part 15, Class “A” Limits: Supporting test records from Hach EMC Test Facility, certified compliance by Hach Company.

This device complies with Part 15 of the FCC Rules. Operation is subject to the following two conditions:

(1) This device may not cause harmful interference, and (2) This device must accept any interference received, including interference that may cause undesired operation. Changes or modifications to this unit not expressly approved by the party responsible for compliance could void the user's authority to operate the equipment.

This equipment has been tested and found to comply with the limits for a Class A digital device, pursuant to Part 15 of the FCC Rules. These limits are designed to provide reasonable protection against harmful interference when the equipment is operated in a commercial environment. This equipment generates, uses, and can radiate radio frequency energy and, if not installed and used in accordance with the instruction manual, may cause harmful interference to radio communications. Operation of this equipment in a residential area is likely to cause harmful interference, in which case the user will be required to correct the interference at his own expense. The following techniques of reducing the interference problems are applied easily.

Certification, continued

1. Remove power from the Pocket Colorimeter instrument by removing one of its batteries to verify that it is or is not the source of the interference.
2. Move the Pocket Colorimeter instrument away from the device receiving the interference.
3. Reposition the receiving antenna for the device receiving the interference.
4. Try combinations of the above.



GENERAL INFORMATION

At Hach Company, customer service is an important part of every product we make.

With that in mind, we have compiled the following information for your convenience.

How to Order

By Telephone:

6:30 a.m. to 5:00 p.m. MST
Monday through Friday
(800) 227-HACH (800-227-4224)

By FAX:

(970) 669-2932 (Hach Loveland)

By Mail:

Hach Company
P.O. Box 389
Loveland, Colorado 80539-0389 U.S.A.

For order information by E-mail:

orders@www.hach.com

Information Required:

- Hach account number (if available)
- Billing address
- Shipping address
- Your name and phone number
- Purchase order number
- Catalog number
- Brief description or model number
- Quantity

How to Order, continued

Technical and Customer Service (USA only)

Hach Technical and Customer Service Department personnel are eager to answer questions about our products and their use and to take your orders. Specialists in analytical methods, they are happy to put their talents to work for you.

Call 1-800-227-4224 or E-mail techhelp@hach.com.

International Customers

Hach maintains a worldwide network of dealers and distributors. To locate the representative nearest you, send E-mail to intl@hach.com or call (970) 669-3050.

In Canada

Hach Instrument Service Centre, Winnipeg, Manitoba, Canada

Telephone: (204) 632-5598; (800) 665-7635

FAX: (204) 694-5134

Repair Service

Authorization must be obtained from Hach Company before sending any items for repair. Please contact the Hach Service Center serving your location.

In the United States:

Hach Company
100 Dayton Avenue
Ames, Iowa 50010
(800) 227-4224 (USA only)
FAX: (515) 232-3835

Latin America, Caribbean, Africa,
Far East, Indian Subcontinent:
Hach Company World Headquarters
P.O. Box 389
Loveland, Colorado 80539-0389 U.S.A.
Telephone: (970) 669-3050
FAX: (970) 669-2932
E-mail: intl@hach.com.

Canada:

Hach Sales & Service Canada Ltd.
1313 Border Street, Unit 34
Winnipeg, Manitoba R3H 0X4
(800) 665-7635 (Canada only)
Telephone: (204) 632-5598
FAX: (204) 694-5134
E-mail: canada@hach.com

Europe, the Middle East,
or Mediterranean Africa:
HACH Company, c/o
Dr. Bruno Lange GmbH & CO. KG
Willstätterstr. 11
40549 Düsseldorf, Germany
Telephone: +49/(0)211/52 88-0
FAX: +49/(0)211/52 88-134

Warranty

Hach Company warrants this product to the original purchaser against any defects that are due to faulty material or workmanship for a period of **two years from date of shipment**.

In the event that a defect is discovered during the warranty period, Hach Company agrees that, at its option, it will repair or replace the defective product or refund the purchase price, excluding original shipping and handling charges. Any product repaired or replaced under this warranty will be warranted only for the remainder of the original product warranty period.

This warranty does not apply to consumable products such as chemical reagents; or consumable components of a product, such as, but not limited to, lamps and tubing.

Contact Hach Company or your distributor to initiate warranty support. Products may not be returned without authorization from Hach Company.

Limitations

This warranty does not cover:

- damage caused by acts of God, natural disaster, labor unrest, acts of war (declared or undeclared), terrorism, civil strife or acts of any governmental jurisdiction
- damage caused by misuse, neglect, accident or improper application or installation
- damage caused by any repair or attempted repair not authorized by Hach Company
- any product not used in accordance with the instructions furnished by Hach Company
- freight charges to return merchandise to Hach Company
- freight charges on expedited or express shipment of warranted parts or product
- travel fees associated with on-site warranty repair

Warranty, continued

This warranty contains the sole express warranty made by Hach Company in connection with its products. All implied warranties, including without limitation, the warranties of merchantability and fitness for a particular purpose, are expressly disclaimed.

Some states within the United States do not allow the disclaimer of implied warranties and if this is true in your state the above limitation may not apply to you. This warranty gives you specific rights, and you may also have other rights that vary from state to state.

This warranty constitutes the final, complete, and exclusive statement of warranty terms and no person is authorized to make any other warranties or representations on behalf of Hach Company.

Limitation of Remedies

The remedies of repair, replacement or refund of purchase price as stated above are the exclusive remedies for the breach of this warranty. On the basis of strict liability or under any other legal theory, in no event shall Hach Company be liable for any incidental or consequential damages of any kind for breach of warranty or negligence.